

LASER MACHINING OF MULTICAPACITANCE FILTERING MLCC'S

ESCURE Pascale⁽¹⁾, LAVILLE Henri⁽²⁾

⁽¹⁾EXXELIA SAS
1, rue des Temps Modernes
77600 Chanteloup-en-brie, FRANCE
Email:pascale.escure@exxelia.com

⁽²⁾EXXELIA SAS
1, rue des Temps Modernes
77600 Chanteloup-en-brie, FRANCE
Email:henri.laville@exxelia.com

STUDY PURPOSE AND EXPECTED RESULTS :

The aim of this work is the development of miniaturized filtering multilayers ceramic capacitors, single or multi capacitance, from various designs, circular miniaturized shapes, or custom-design shapes (see fig.1, 2 and 3) :



Fig. 1 : Circular miniaturized single capacitance model



Fig.2 : Circular miniaturized multicapacitance model

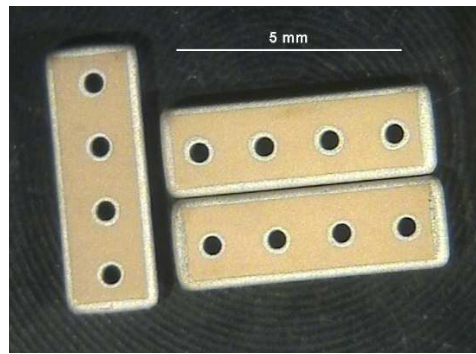

Fig.3 : Custom-design model

These special designs, for the most reduced dimensions, are only accessible by green machining of the MLCC's. This step is one of the most critical in the MLCC's manufacturing process, because every mistake can generate direct electrical defects or can lead to a reduced reliability of the parts.

Present machining is mechanical, and available tools (trimming/drilling equipments, cutters, drills...) doesn't allow to decrease dimensions of parts to be machined anymore. Moreover, these technologies are time consuming and expensive.

Exxelia proposes to totally change the machining process, by **using laser as machining tool**.

This machining process has already been tested to realize C4N PDL parts range (see Fig.4), which dimensions are similar to a 1206 case (3.12mm x 1.6mm, 4 capacitances network).

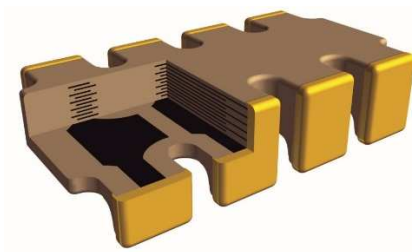

Fig.4 : C4N PDL model

This process is very precise and allows to **increase accuracy of designs** attainable and also to **rise circuits' integration**.

Moreover, laser machining is much "cleaner" than a standard mechanical machining, that generates scraps very difficult to eliminate on tinny cases. Electrode edges are much cleaner and therefore allow a **better quality of the internal electrode-end termination connection**.

CONTEXT

Main application for components for which laser machining will be used is filtering, for single or multiple lines (as micro D filtering connectors for example) ; flexibility of laser machining allows to realize capacitors with shapes **that perfectly fit units to be filtered** (which means **space saving, higher integration...**).

PLANNED ACTIVITIES AND KEY-STEP

This study allows Exxelia to evaluate and validate new processes, laser machining and also robotized deposit for end termination.

Test vehicles definition :

Specific designs and manufacturing lines choice (see Fig.5 : micro TBC*, or 2-capacitances TBC*, multi-capacitance insert)

* : TBC = Feedthrough shape capacitor

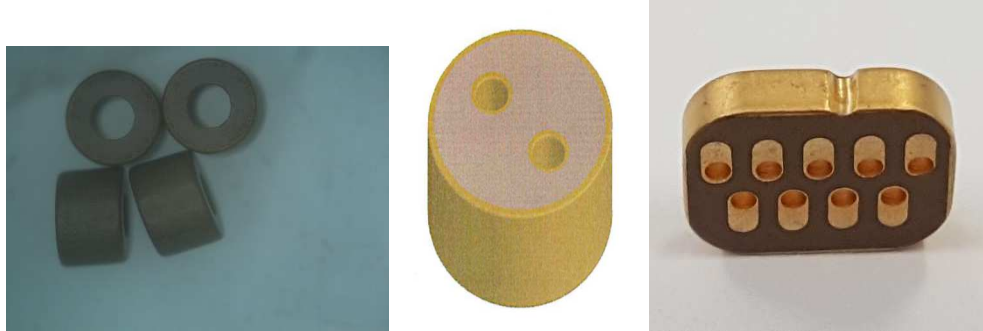

Fig.5 : Micro TBC / 2-capacitances TBC / multi-capacitance insert

Tools conception :

Manufacturing tools, which are specific on the models chosen for this study, as films and screens for screen-printing, have been designed (Fig. 6) and manufactured.

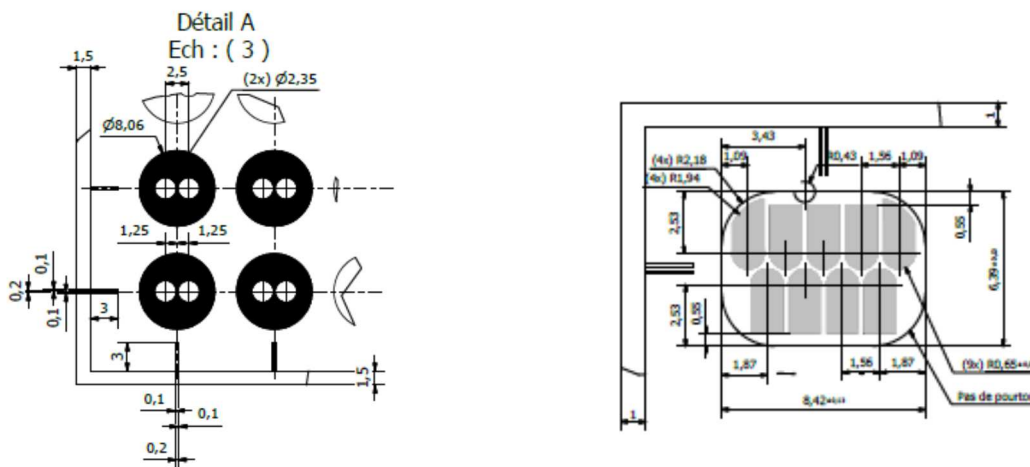

Fig.6 : 2-capacitances TBC / multi-capacitance insert screen-printing partial designs

Laser machining definition :

Laser machining drawings (Fig.7) are been defined and laser parameters adapted to obtain the better geometrical definition ; if the part is thick (about 2mm green and more), depending on laser available, cutting is done in 2 steps by reversal.

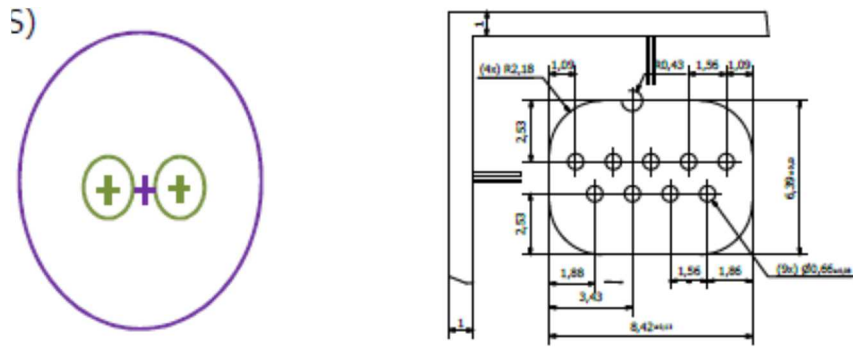

Fig.7 : 2-capacitances TBC / multi-capacitance insert laser machining partial designs

MLCC's stacks manufacturing :

All steps of MLCC's stacks (Fig.8 for multi-capacitance insert) are done following Exxelia manufacturing specifications, on standard production lines (no specific parameters). The laser machining is done after stacking and pressing completion.

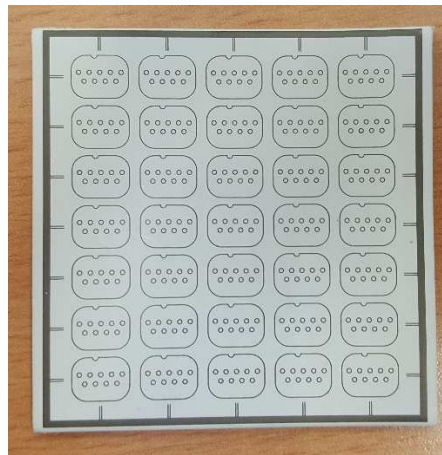

Fig.8 : multi-capacitance insert stack, before laser machining

Laser machining :

After laser machined (Fig.9-1), unit green components are extracted from machined block (Fig. 9-2).

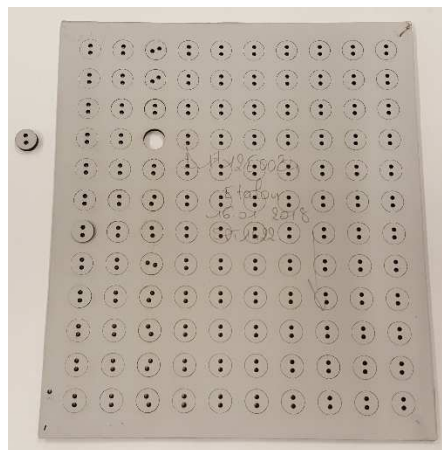

Fig.9-1 : 2-capacitances TBC after laser machining

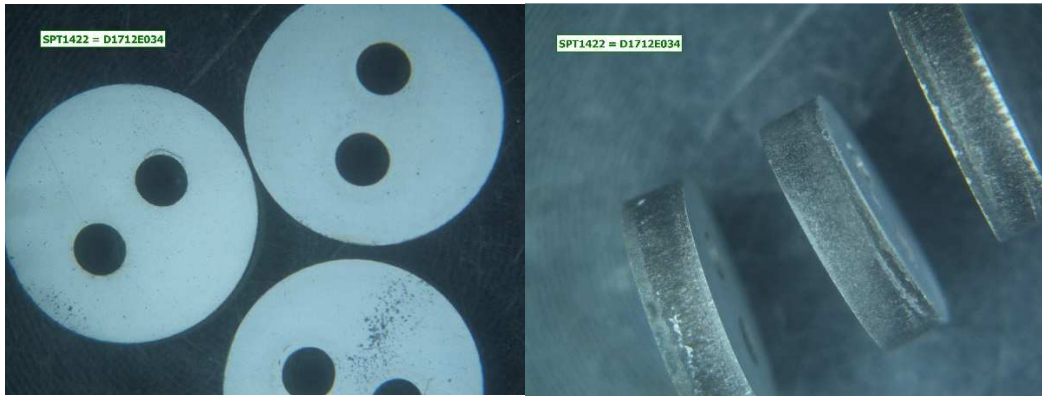

Fig.9-2 : 2-capacitances TBC after laser machining

To evaluate laser machining quality (precision of laser cutting and influence of laser cutting on electrical properties), parts are fired, corner-rounded (Fig. 10) and metallized (end termination deposition).



Fig.10 : 2-capacitances TBC after burn-out, sintering and corner-rounding

Termination process :

End termination has to be put on the edge of a circular shapes for 2-capacitances TBC model : standard TBC Exxelia process can be used (roll equipment), with specific tool (Fig.11).



Fig.11 : 2-capacitances TBC after roll end termination

For multi-capacitance insert, which is a non circular and non rectangular shape, Exxelia is studying a new termination process : a 3 or 4 axes robot puts solderable end termination on the edge of the insert. Choice of the

robot model and deposit parameters is a main part of this study. To prove feasibility of this technic, some preliminary tests have been done : syringe manual deposit (Fig.12) and robot deposit (Fig.13), on standard 2220 MLCC's.



Fig.12 : end termination manual syringe deposit on 2220 parts

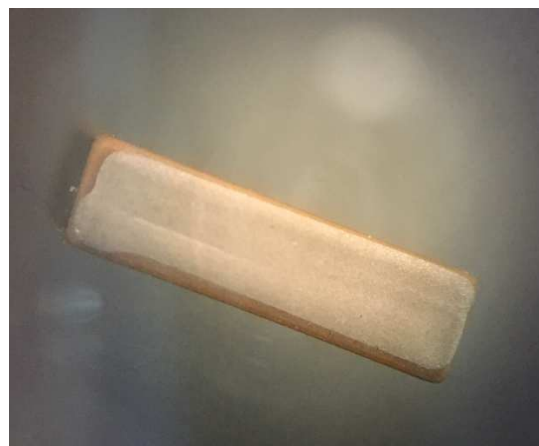

Fig.13 : end termination robot deposit on 2220 parts

Of course deposit parameters and end termination rheology have to be adapted to reach a fired end termination compatible with customer soldering requirements, but feasibility of robot deposit is validated.

Electrical characterization of laser machined parts :

On 2-capacitances TBC parts, which can be terminated with standard equipment (with specific tool), basic electrical parameters have been controlled (see Fig.14) : capacitance values (both capacitances tested on 20 parts) spray from only -5% up to +1.5% of nominal capacitance value (50nF), which is a quite tight distribution.

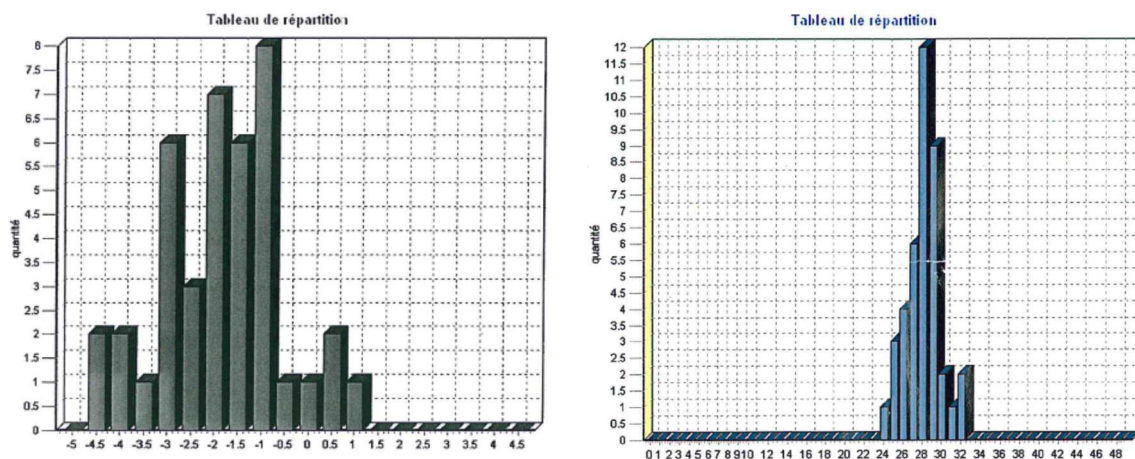

Fig.14 : capacitance distributions (% of 50nF nominal value) on 2 different

2-capacitances TBC parts series

This behavior can be due to a better cut of electrodes ends, allowing a better adhesion between electrodes and termination, but these behavior and hypothesis have to be re-checked on other series.

Electrical characterization tools development :

To control multi-capacitances insert, some specific tool is needed : a tweezer, with pins small enough to go in the holes of the insert, has already been developed for preliminary manual tests.

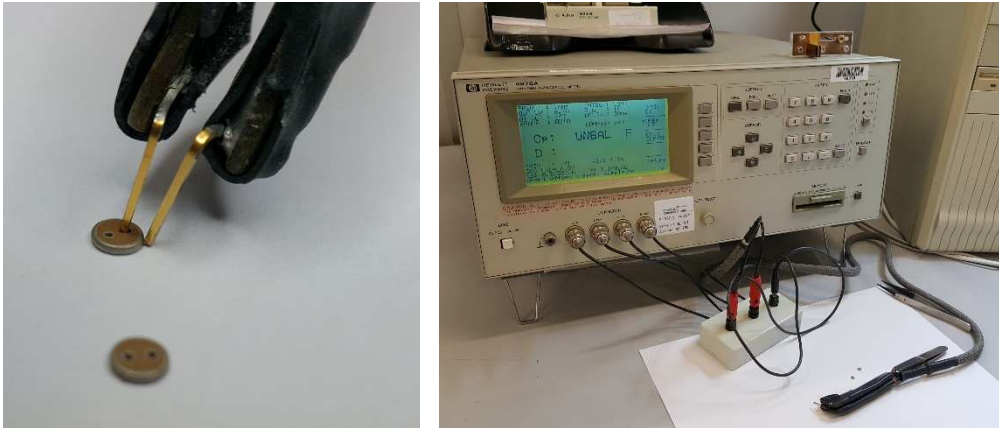

Fig.15 : tweezer for multi-capacitance parts preliminary manual capacitance control tests

Other steps :

Other steps of the study are :

- MLCC's characterization
- Filters assembly
- Pre-evaluation vs space requirements

NB : Project involved in CNES 2018 R&T actions (R-S18/MT-0004-220).